



TECHNICAL DATA

SK-2200
SK-2210
AIR SYSTEM SOCKET
SK-2216
AIR CHIMNEY

The EIMAC SK-2200 and SK-2210 are air-system sockets recommended for use with the EIMAC 8877/3CX1500A7 triode. A companion chimney is available, which will operate with either socket.

With these sockets, connection is made to each tube element except the anode.

No contacts are grounded on the SK-2200, while the SK-2210 has the grid contacts grounded to the equipment chassis when installed.

INSTALLATION

The SK-2200 and SK-2210 are designed for under-chassis mounting, and require a 3/4 inch hole through the chassis deck. Each socket is held in place by four 6-32 screws.

AIR CHIMNEY

The SK-2216 chimney is made of low-loss teflon. It is held in place with four toe clamps which are supplied with the chimney.

NET WEIGHTS

SK-2200 Socket	4.5oz; 128 gm
SK-2210 Socket	4.0 oz; 113 gm
SK-2216 Chimney	2.0 oz; 56.7 gm

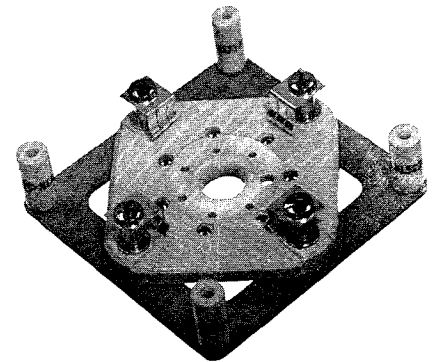

SK-2200

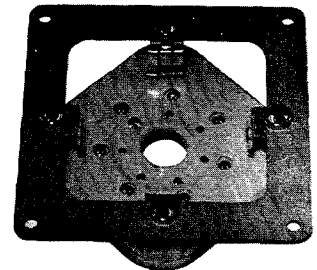

SK-2210

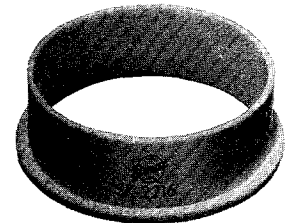

SK-2216

SK-2200/SK-2210

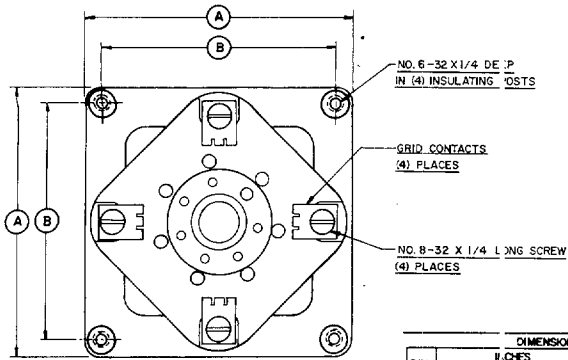

DIM.	INCHES			MILLIMETERS		
	MIN.	MAX.	REF.	MIN.	MAX.	REF.
A	3.373	3.413	--	85.67	86.70	--
B	2.953	2.983	--	75.01	75.77	--
C	0.500	0.550	--	12.70	13.97	--
D	--	0.330	--	--	16.00	--

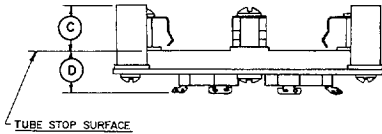
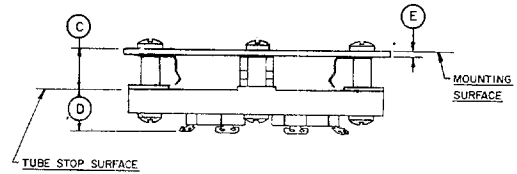
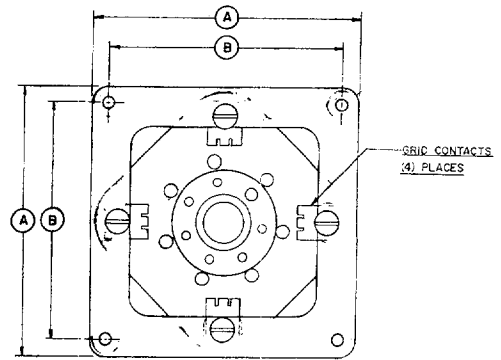

- NOTES:**
 1. REF. DIMENSIONS ARE FOR INFO. ONLY & ARE NOT REQUIRED FOR INSPECTION PURPOSES.
 2. CONNECTIONS:
 1-HEATER
 2-CATHODE
 3-CATHODE
 4-CATHODE
 5-HEATER
 6-CATHODE
 7-CATHODE
 3. GRID CONTACTS INSULATED FROM GRID & OTHER ELEMENTS.

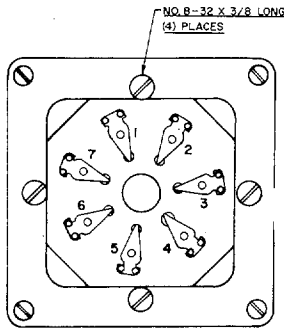

SK-2200 Socket

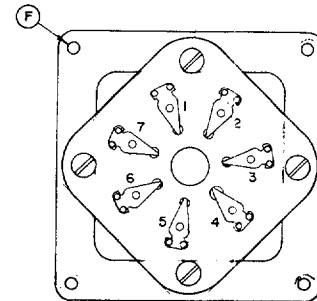

SK-2210 Socket

DIM.	INCHES			MILLIMETERS		
	MIN.	MAX.	REF.	MIN.	MAX.	REF.
A	3.373	3.413	--	85.67	86.70	--
B	2.953	2.983	--	75.01	75.77	--
C	0.474	0.593	--	12.04	14.05	--
D	--	0.630	--	--	16.00	--
E	--	--	0.063	--	1.60	--
F	0.140	0.149	--	3.56	3.78	--

- NOTES:**
 1. REF. DIMENSIONS ARE FOR INFO. ONLY & ARE NOT REQUIRED FOR INSPECTION PURPOSES.
 2. CONNECTIONS:
 1-HEATER
 2-CATHODE
 3-CATHODE
 4-CATHODE
 5-HEATER
 6-CATHODE
 7-CATHODE
 3. GRID CONTACTS BOUNDED TO MOUNTING PLATE.

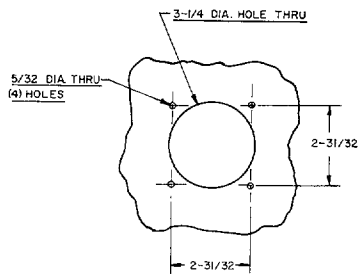

CHASSIS CUT OUT FOR MOUNTING & REQUIRED COOLING AIR FLOW.

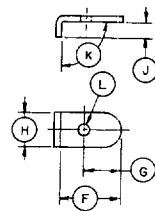

TOE CLAMP DETAIL (4) SUPPLIED P/N 889901

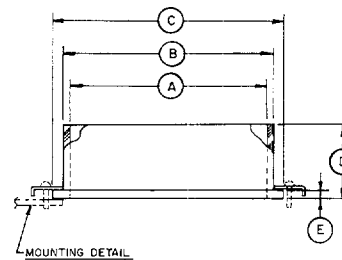

SK-2216 Chimney

DIM.	INCHES			MILLIMETERS		
	MIN.	MAX.	REF.	MIN.	MAX.	REF.
A	3.385	3.415	--	85.98	86.74	--
B	3.532	3.592	--	89.71	91.24	--
C	3.907	3.967	--	99.24	100.76	--
D	1.220	1.280	--	30.99	32.51	--
E	0.410	0.440	--	10.29	11.16	--
F	0.282	0.332	--	7.22	8.43	--
G	0.282	0.332	--	7.22	8.43	--
H	0.282	0.332	--	7.22	8.43	--
J	0.105	0.145	--	2.67	3.68	--
K	80°	100°	--	80°	100°	--
L	0.142	0.146	--	3.61	3.71	--

- NOTES:**
 1. REF. DIMENSIONS ARE FOR INFO. ONLY & ARE NOT REQUIRED FOR INSPECTION PURPOSES.
 2. MATERIALS:
 a. CHIMNEY: TEFLOW TFE
 b. TOE CLAMP: BRASS-SILVER PLATED

